

# PLA-RP Heat Pump

## R407c 4-Way Blow Ceiling Cassette System

New Models

- > Airflow controllable for ceiling heights up to 4.2m
- > Electronic fan speed control
- > Quiet start up cycle

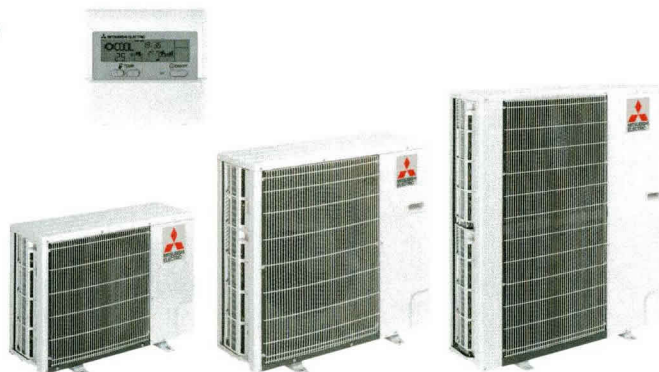

Technical Information >>

### PLA-RP - INDOOR UNITS

MODEL REFERENCE		PLA-RP35AA	PLA-RP50AA	PLA-RP60AA	PLA-RP71AA	PLA-RP100AA	PLA-RP125AA	PLA-RP140AA
CAPACITY (kW)	Heating (nominal)	4.95	6.35	7.3	9.2	10.5	15.6	17.0
	Cooling (nominal)	4.5	5.6	6.7	7.7	9.6	13.3	14.2
	Heating (UK)	4.2	5.4	6.2	7.8	8.95	13.25	14.45
	Cooling (UK)	4.05	5.05	6.05	6.95	8.65	11.95	12.8
SHF (nominal)		0.75	0.82	0.72	0.74	0.78	0.72	0.69
AIRFLOW (m3/min)	Lo-Mi1-Mi2-Hi	11-12-13-14	14-15-16-18	14-15-16-18	15-16-18-20	20-23-26-28	22-25-28-30	22-25-28-30
PIPE SIZE mm(in)	Gas	15.88 (5/8")	15.88 (5/8")	15.88 (5/8")	15.88 (5/8")	19.05 (3/4")	19.05 (3/4")	19.05 (3/4")
	Liquid	9.52 (3/8")	9.52 (3/8")	9.52 (3/8")	9.52 (3/8")	9.52 (3/8")	9.52 (3/8")	9.52 (3/8")
NOISE (dBA)	Lo-Mi1-Mi2-Hi	27-28-29-31	28-29-31-33	28-29-31-33	28-30-32-34	33-36-39-41	37-40-43-45	37-40-43-45
DIMENSIONS (mm) (grille)	Width	840 (950)	840 (950)	840 (950)	840 (950)	840 (950)	840 (950)	840 (950)
	Depth	840 (950)	840 (950)	840 (950)	840 (950)	840 (950)	840 (950)	840 (950)
	Height	258 (30)	258 (30)	258 (30)	258 (30)	298 (30)	298 (30)	298 (30)
WEIGHT (kg)	Unit	24	24	24	24	30	32	32
	Panel	5	5	5	5	5	5	5
ELECTRICAL SUPPLY		Fed by Outdoor Unit	Fed by Outdoor Unit	Fed by Outdoor Unit	Fed by Outdoor Unit	Fed by Outdoor Unit	Fed by Outdoor Unit	Fed by Outdoor Unit
PHASE		Single	Single	Single	Single	Single	Single	Single
FUSE RATING (BS88) – HRC (A)		6	6	6	6	6	6	6
INTERCONNECTING CABLE No. CORES		4	4	4	4	4	4	4
GRILLE REFERENCE		PLP-6AA	PLP-6AA	PLP-6AA	PLP-6AA	PLP-6AA	PLP-6AA	PLP-6AA
WIRED REMOTE CONTROLLER REFERENCE		PAR-21MAA	PAR-21MAA	PAR-21MAA	PAR-21MAA	PAR-21MAA	PAR-21MAA	PAR-21MAA

### PUH-P - OUTDOOR UNITS

MODEL REFERENCE		PUH-P35VGAA	PUH-P50VGAA	PUH-P60VGAA	PUH-P71VGAA/YGAA	PUH-P100VGAA/YGAA	PUH-P125YGAA	PUH-P140YGAA
NOISE (dBA)	Heating/Cooling	49 / 47	49 / 48	50 / 48	51 / 49	53 / 51	56 / 55	58 / 57
WEIGHT (kg)		54	74	79	79	97	125	125
DIMENSIONS (mm)	Width	900	900	900	900	900	1050	1050
	Depth	330 + 20	330 + 20	330 + 20	330 + 20	330 + 20	330 + 20	330 + 20
	Height	650	855	855	855	1260	1260	1260
ELECTRICAL SUPPLY		220-240v, 50Hz	220-240v, 50Hz	220-240v, 50Hz	220-240v,50Hz / 380-415,50Hz	220-240v,50Hz / 380-415,50Hz	380-415v, 50Hz	380-415v, 50Hz
PHASE		Single	Single	Single	Single / 3	Single / 3	3	3
SYSTEM POWER INPUT (kW)	Heating/Cooling (nominal)	1.70 / 1.72	2.20 / 2.53	2.40 / 2.57	3.48 / 3.42	3.91 / 3.68	5.54 / 5.09	6.35 / 5.90
	Heating/Cooling (UK)	1.51 / 1.46	1.96 / 2.15	2.14 / 2.18	3.10 / 2.91	3.48 / 3.13	4.93 / 4.33	5.65 / 5.02
STARTING CURRENT (A)		36	62	77	93 / 47	99 / 49	65.5	74
SYSTEM RUNNING CURRENT (A) Heating/Cooling		8.38 / 8.15	11.36 / 11.05	12.3 / 12.69	16.55/15.6 / 6.42/6.08	17.83/16.96 / 7.11/6.8	9.79 / 9.24	11.2 / 10.67
FUSE RATING (BS88) – HRC (A)		16	16	25	32 / 16	32 / 20	20	25
MAINS CABLE No. Cores		3	3	3	3 / 5	3 / 5	5	5
MAX PIPE LENGTH (m)		40	40	50	50	50	50	50
MAX HEIGHT DIFFERENCE (m)		40	40	50	50	50	50	50
CHARGE R407c (kg)		2.5	2.6	3.1	3.3	4.0	4.6	4.9

Notes: Optional infra-red grille and remote controller available. All units are charged to 20m (35-60) and 30m (71-140) pipe length.

# INDOOR UNIT PLA-RP35-I40AA

Ceiling Hole 860 ~ 910 x 860 ~ 910

Side View >

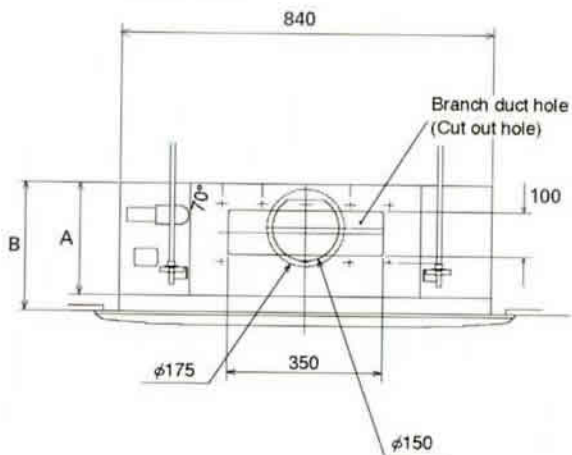

Models	A	B
Size 35-71	241	258
Size 100-140	281	298

Lower View >

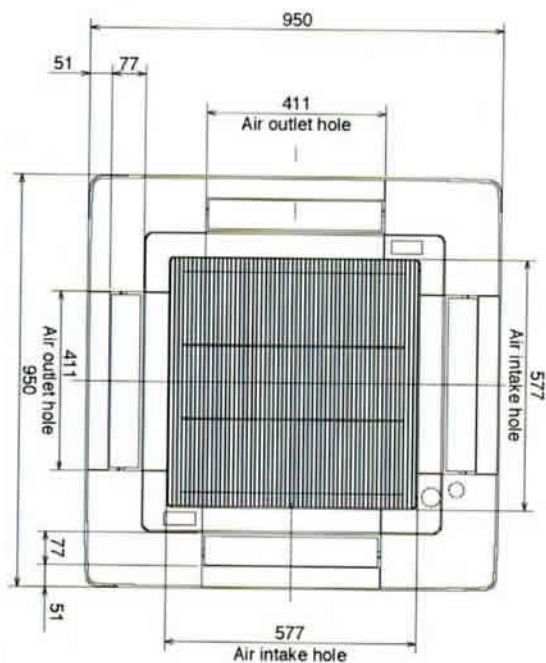

# Outdoor Units

PU-P50-71VGAA/YGAA / PUH-P50-71VGAA/YGAA

Upper View >

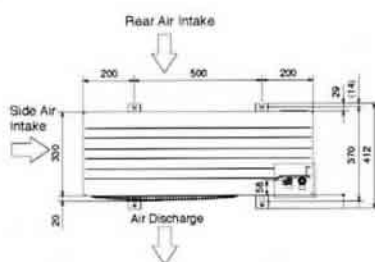

Rear View >



Left Side View >

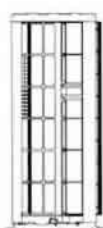

Front View >

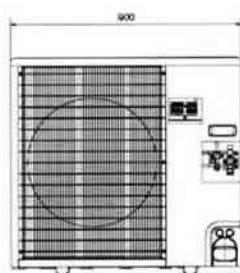

Right Side View >



PU-PI00YGAA / PUH-PI00VGAA/YGAA

Upper View >

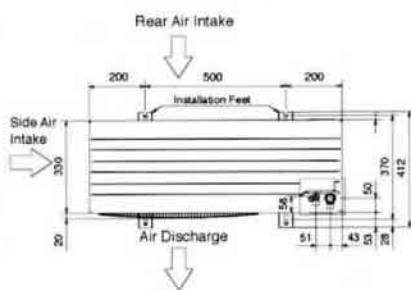

Rear View >

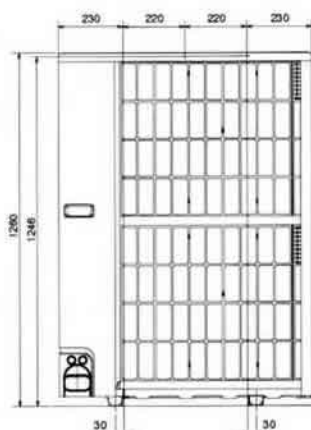

Left Side View >

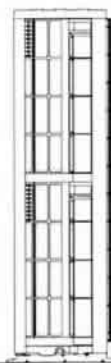

Front View >

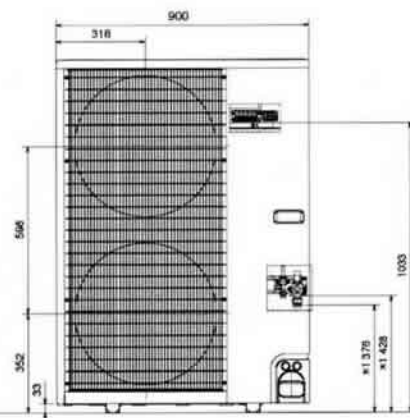

Right Side View >



PU-PI25/I40YGAA / PUH-PI25/I40YGAA

Upper View >

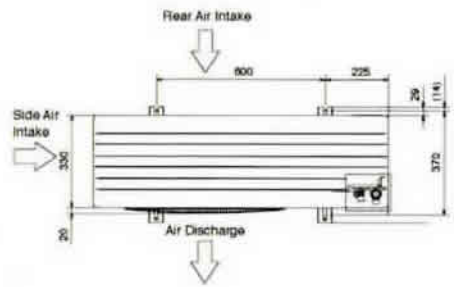

Rear View >

Left Side View >

Front View >

Right Side View >

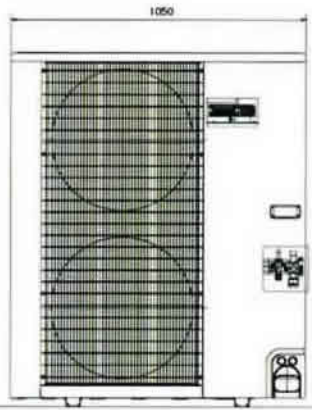
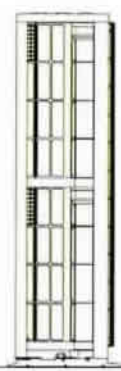

**This pdf has been downloaded from the website of :**

“Supplying and installing the latest in air conditioning technology”

**° Celsius**  
**air conditioning**

Celsius Air Conditioning Ltd, I Well Street, Heywood, Greater Manchester OL10 INT

 01706 367 500  07000 CELSIUS  01706 367 355  sales@celsiusair.co.uk  www.celsiusair.co.uk

**www.celsiusair.co.uk**