



# Celsius

air conditioning



## MSZ-GE50VA

Inverter Heat Pump

R410A Wall Mounted System

This model has been completely redesigned and features the new Catechin filter system. It offers industry leading noise levels and also includes a wide swing & long airflow mode.

- **Anti-Allergy Enzyme filter is optional**

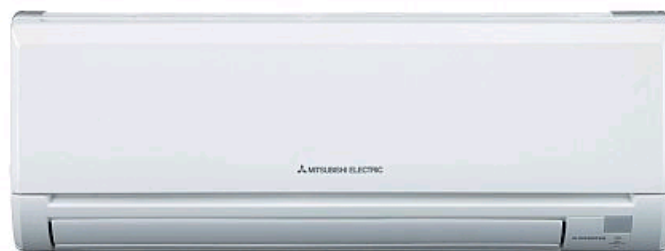

Pictures not to scale

## Product Details

MSZ-GE50VA Indoor Unit	
Capacity (kW):	
Heating (Nominal) (Low - High)	5.80 (1.40 - 7.30)
Cooling (Nominal) (Low - High)	5.00 (1.40 - 5.50)
Heating (UK) (Low - High)	4.80 (1.15 - 6.05)
Cooling (UK) (Low - High)	4.95 (1.40 - 5.45)
SHF R410A (Nominal)	0.76
COP / EER (Nominal)	3.71 / 3.3
Energy Label Heating / Cooling	A / A
Width - mm	798
Depth - mm	232
Height - mm	295
Weight - kg	10
Airflow (m <sup>3</sup> /min) (Heating /Cooling) - Lo-Mi1-Mi2-Hi-SupHi	6.5-7.8-9.6-12.2-14.5 / 6.5-7.8-9.6-11.9-15.1
Noise (dBA) (Heating /Cooling) - Lo-Mi1-Mi2-Hi-SupHi	28-33-37-43-48 / 28-33-38-44-49
Pipe Size Gas mm (in)	12.7 (1/2)
Pipe Size Liquid mm (in)	6.35 (1/4)
Electrical Supply	Fed by Outdoor Unit
Phase	Single
Fuse Rating (BS88) - HRC (A)	6
Interconnecting Cable No. Cores	4

MUZ-GE50VA Outdoor Unit	
Width - mm	840
Depth - mm	330
Height - mm	850
Weight - kg	54
Noise (dBA) (Heating /Cooling)	56 / 54
Electrical Supply	220-240v, 50Hz
Phase	Single
Fuse Rating (BS88) - HRC (A)	16
SystemPower Input (kW) - Heating (Nominal)	1.565
SystemPower Input (kW) - Cooling (Nominal)	1.515
SystemPower Input (kW) - Heating (UK)	1.424
SystemPower Input (kW) - Cooling (UK)	1.212
Starting Current (A)	7
SystemRunning Current (A) - Heating / Cooling	7 / 6.8
Mains Cable No. Cores	3
Max Pipe Length (m)	30
Max Height Difference (m)	15
Charge (kg) - 7m	1.55

## Dimensions

### MSZ-GE50VA

Upper View >

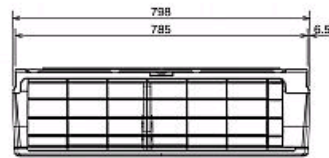

Front View >

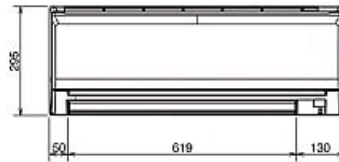

Side View >

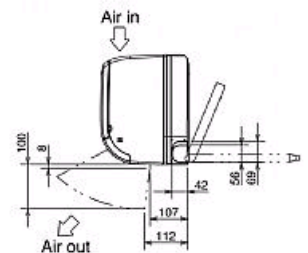

### MUZ-GE50VA

Upper View >

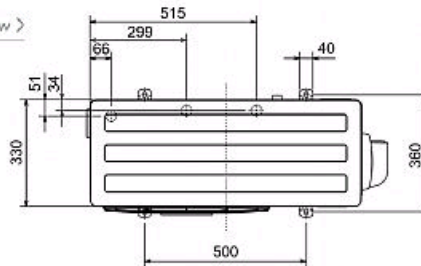

Front View >

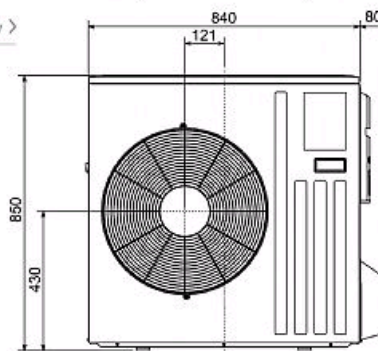

Side View >

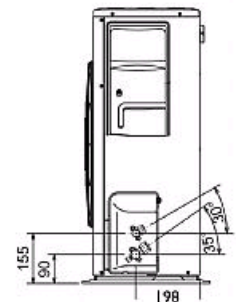

Telephone: 01707 282880

Email: [air.conditioning@meuk.mee.com](mailto:air.conditioning@meuk.mee.com) Website: <http://www.mitsubishielectric.co.uk/aircon>

CELSIUS AIR CONDITIONING LTD

1, WELL STREET

HEYWOOD

OL10 1NT

Tel: 01706 367500

Fax: 01706 367355



Mitsubishi Electric reserves the right to make any variation in technical specification to the equipment described, or to withdraw or replace products without prior notification or public announcement.