



PEAD-RP60JA

Standard Inverter Heat Pump

R410A Ceiling Concealed Ducted System

The new Standard Inverter range provides inverter solutions for customers who want all the benefits that inverters offer, but do not have the budget available for the more expensive Power Inverter range.



Pictures not to scale

Product Details

PEAD-RP60JA Indoor Unit

Capacity (kW):	
Heating (Nominal) (Low - High)	7.00 (0.90 - 8.00)
Cooling (Nominal) (Low - High)	5.70 (1.10 - 6.30)
Heating (UK) (Low - High)	5.80 (0.75 - 6.65)
Cooling (UK) (Low - High)	5.65 (1.10 - 6.25)
SHF R410A (Nominal)	0.86
COP / EER (Nominal)	3.61 / 3.39
Energy Label Heating / Cooling	A / A
Width - mm	1100
Depth - mm	732
Height - mm	250
Weight - kg	33
Airflow (m3/min) - Lo-Mi-Hi	14.5-18-21
External Static Pressure Pa - Lo-Mid-Hi	35-70-150
Noise (dBA) - Lo-Mi-Hi	25-29-33
Pipe Size Gas mm (in)	15.88 (5/8)
Pipe Size Liquid mm (in)	6.35 (1/4)
Electrical Supply	Fed by Outdoor Unit
Phase	Single
Fuse Rating (BS88) - HRC (A)	6
Interconnecting Cable No. Cores	4

SUZ-KA60VA2 Outdoor Unit

Width - mm	840
Depth - mm	330
Height - mm	850
Weight - kg	53
Noise (dBA) (Heating /Cooling)	55 /53
Electrical Supply	220-240v, 50Hz
Phase	Single
Fuse Rating (BS88) - HRC (A)	20
SystemPower Input (kW) - Heating (Nominal)	1.94
SystemPower Input (kW) - Cooling (Nominal)	1.68
SystemPower Input (kW) - Heating (UK)	1.77
SystemPower Input (kW) - Cooling (UK)	1.34
Starting Current (A)	9.75
SystemRunning Current (A) - Heating / Cooling	11.37 / 9.97
Mains Cable No. Cores	3
Max Pipe Length (m)	30
Max Height Difference (m)	30
Charge (kg) - 7m	1.8

Dimensions

PEAD-RP60JA

Front View >

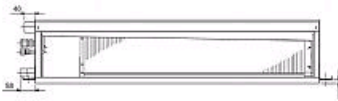

Rear View >

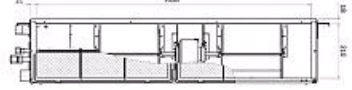

Upper View >

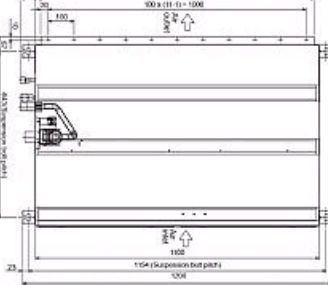

Side View >

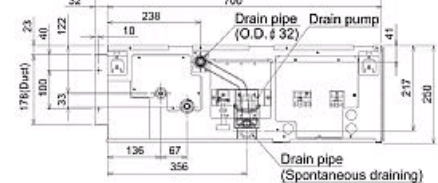

SUZ-KA60VA2

Upper View >

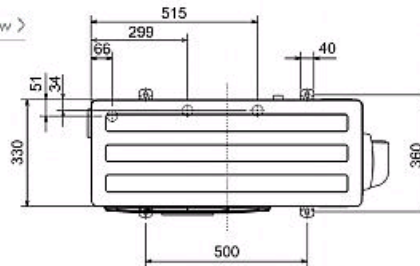

Front View >

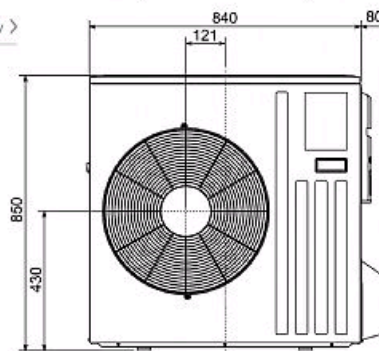

Side View >

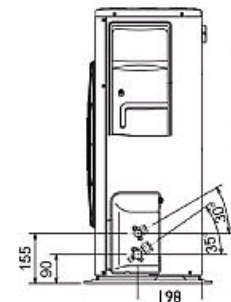

Telephone: 01707 282880

Email: air.conditioning@meuk.mee.com Website: <http://www.mitsubishielectric.co.uk/aircon>

CELSIUS AIR CONDITIONING LTD

1, WELL STREET

HEYWOOD

OL10 1NT

Tel: 01706 367500

Fax: 01706 367355



Mitsubishi Electric reserves the right to make any variation in technical specification to the equipment described, or to withdraw or replace products without prior notification or public announcement.